

Banc GAVIOTAS



Description

Assise en béton UHPC (ciment certifié eco operando) et base en béton Petra 1. Le ciment certifié eco operando émet 35% d'émissions de CO2 en moins que le ciment ordinaire. Agrégats siliceux.

Dimensions

Longueur : 200 cm
Hauteur assise : 45 cm
Hauteur dossier : 91 cm
Largeur 85 cm

Poids

480 kg

Les options

Autres coloris (nous consulter, augmentation en fonction de la couleur. *Demander un devis.*)

Couleurs de finition

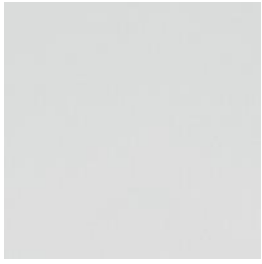

Blanc

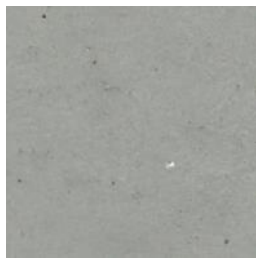

Gris

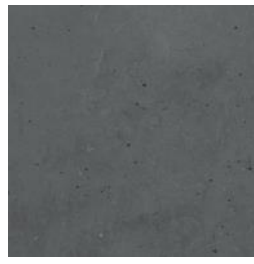

Noir

Finition de surface

Revêtements composés de liants qui intègrent des charges de métal concassé et donnent aux éléments urbains l'apparence réelle du métal ainsi que son oxydation et ne se détériorent pas avec le temps.



Bronze



Corten



Golden



Noir graphite

CARACTERISTIQUES

Matériel Béton UHPC + PETRA 1
Finition Hydrofugé
Dimensions l. 200, a. 85, h. 91 cm.
Couleur voir p.2
Fixation résine époxy
Poids 485 Kg / 385 Kg
Palette 200x195x35 cm / 120x33x45 cm
Poids palette 500 Kg / 400 kg



+33 297 639 431
 info@avenir-voirie.fr

design: Ewald Winkelbauer

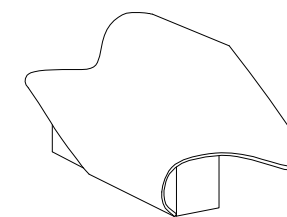
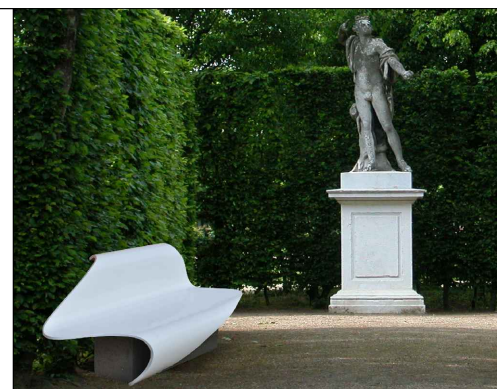

GAVIOTAS

GEOMETRIE

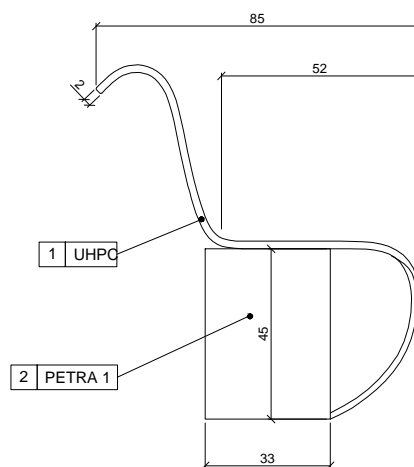
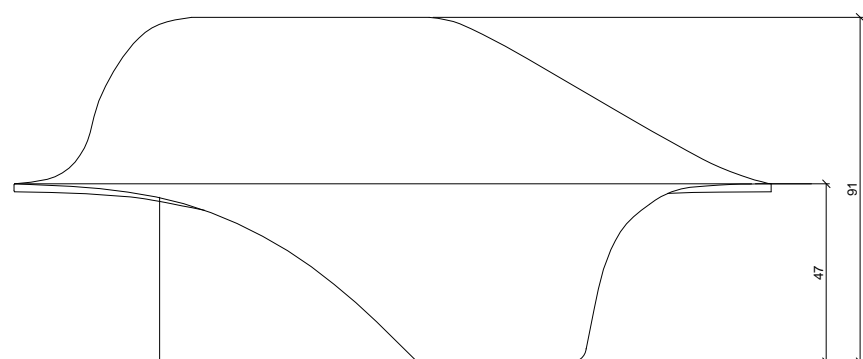

PROFIL

SOULEVE

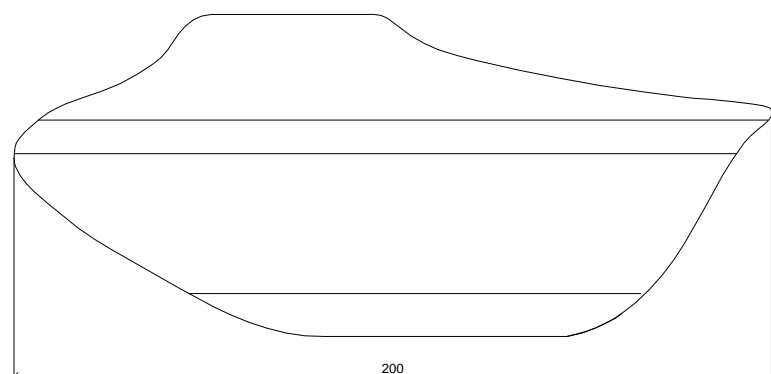

FACE

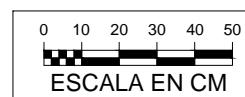

MANIPULATION ET INSTALLATION

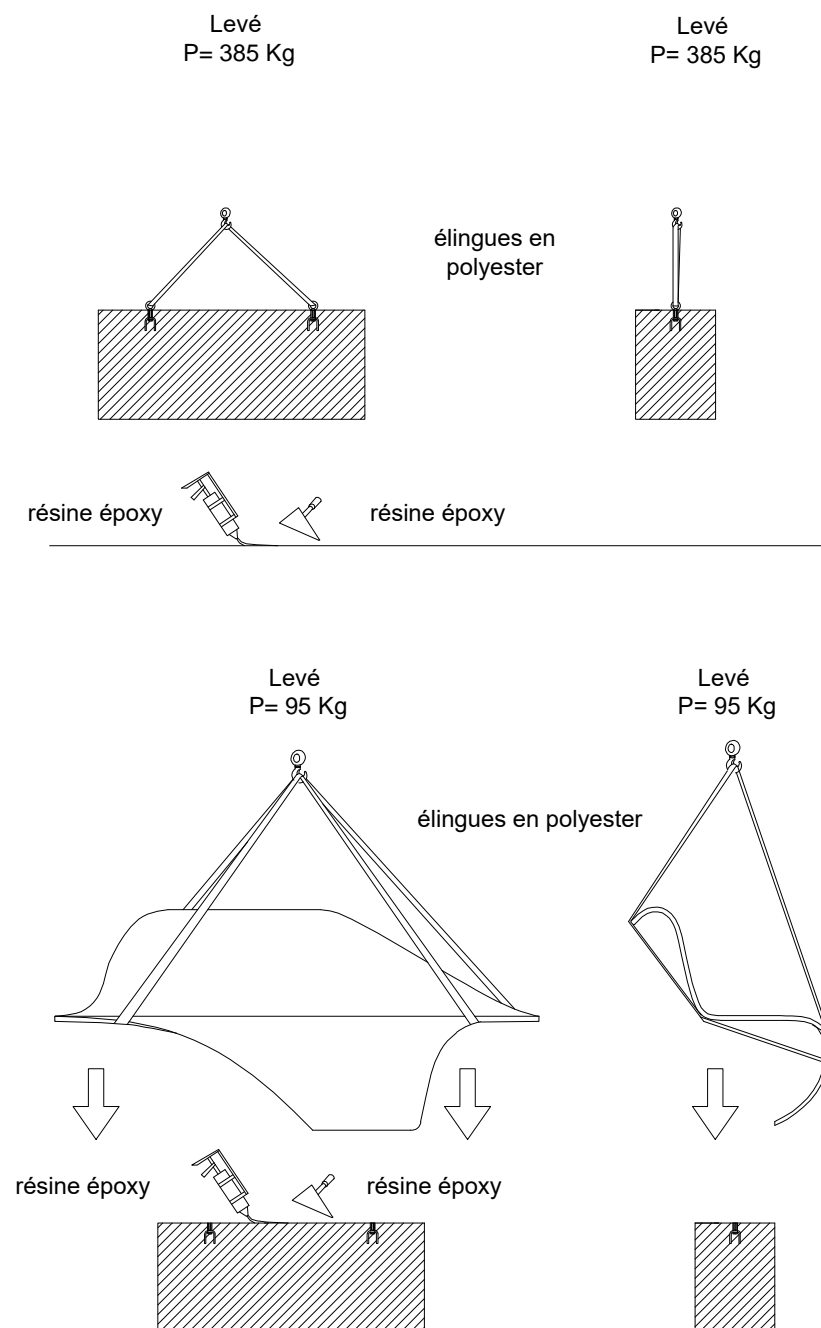

SPECIFICATIONS

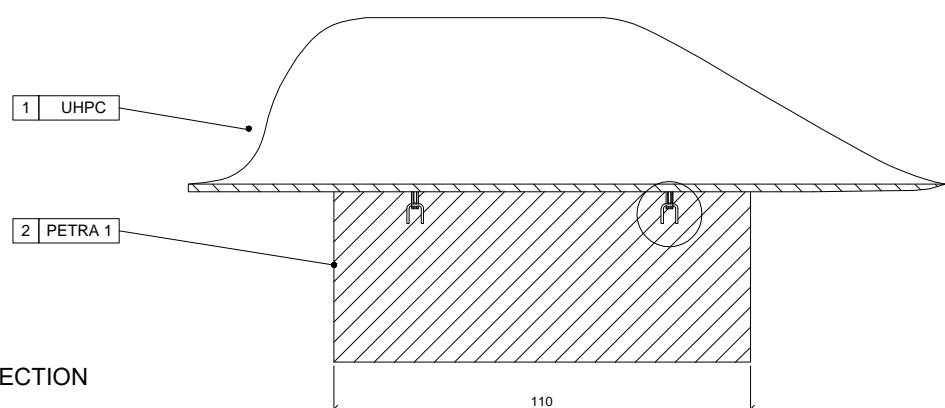

SECTION

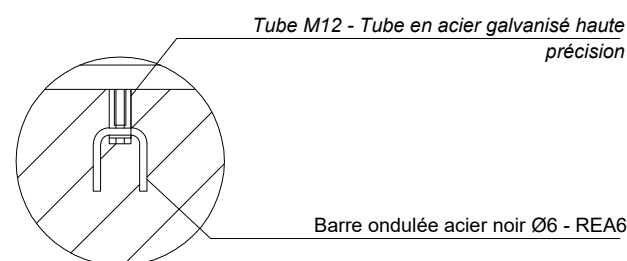

- 1 GAVIOTAS: 95Kg
- 2 BASE: 385Kg