

Assise DYNAMIC Q100



Description

Assise en ciment hydrofugé (ciment certifié eco operando). Le ciment certifié eco operando émet 35% d'émissions de CO2 en moins que le ciment ordinaire. Agrégats marbre ou carrière concassée.

Dimensions

Longueur : 100 cm

Largueur : 100 cm

Hauteur : 45 cm

Poids

740 kg

Les options

Autres coloris (nous consulter, augmentation en fonction de la couleur. *Demander un devis.*)

Points de connexion intelligents via un panneau photovoltaïque installé dans la base pour : recharge sans fil d'appareils électroniques, chargement USB rapide, connexion Wifi, éclairage LED pour éclairer indirectement l'espace urbain.

Couleurs de finition

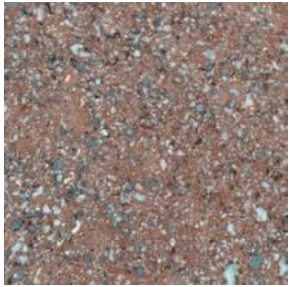

Marron



Noir



Ocre

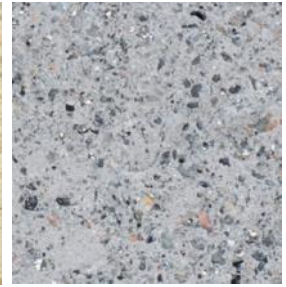

Gris

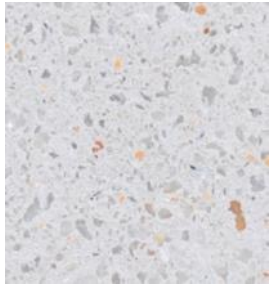

Blanc

Finition de surface

Revêtements composés de liants qui intègrent des charges de métal concassé et donnent aux éléments urbains l'apparence réelle du métal ainsi que son oxydation et ne se détériorent pas avec le temps.



Corten



Noir graphite

Couleurs en options



CARACTERISTIQUES

Materiel Béton petra 1
Finition Hydrofugé
Dimensions 100 x 100 x 45 cm
Couleur voir p.2
Poids 740 Kg



+33 297 639 431
 info@avenir-voirie.fr

design: magourban

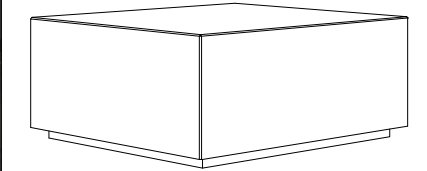

DYNAMIC Q-100

GEOMETRIE

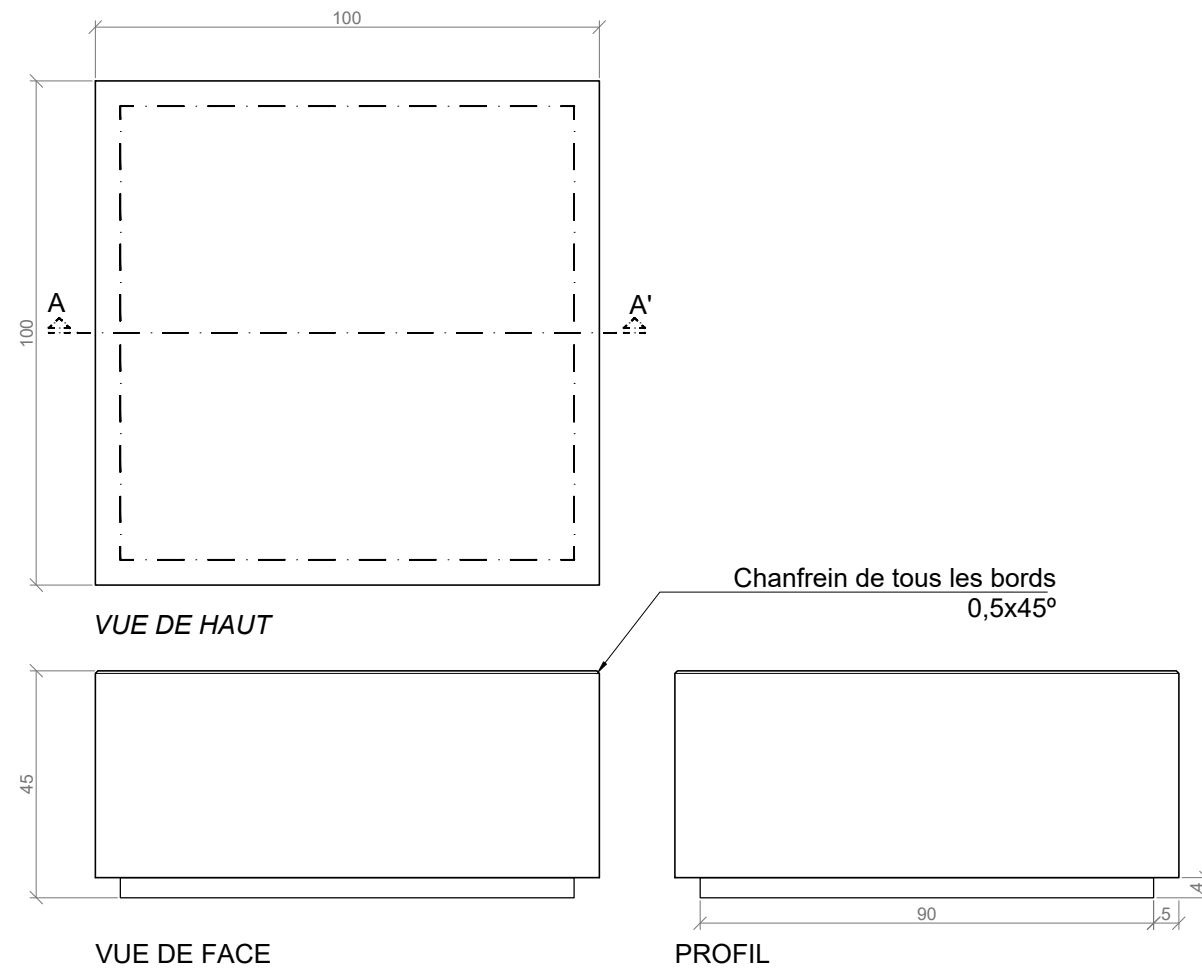

ESC.: 1/15

MANIPULATION ET INSTALLATION

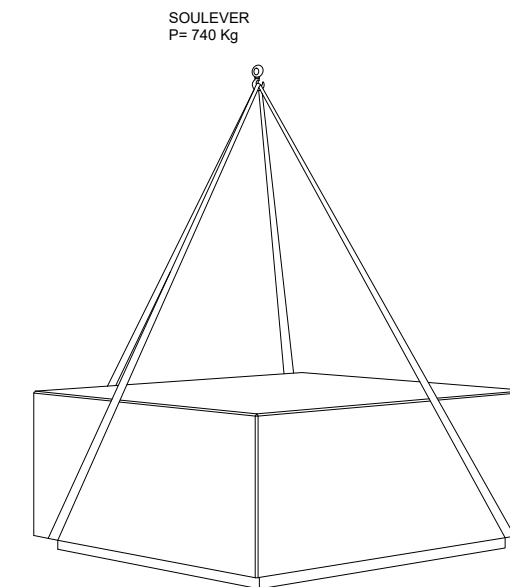

SPECIFICATIONS

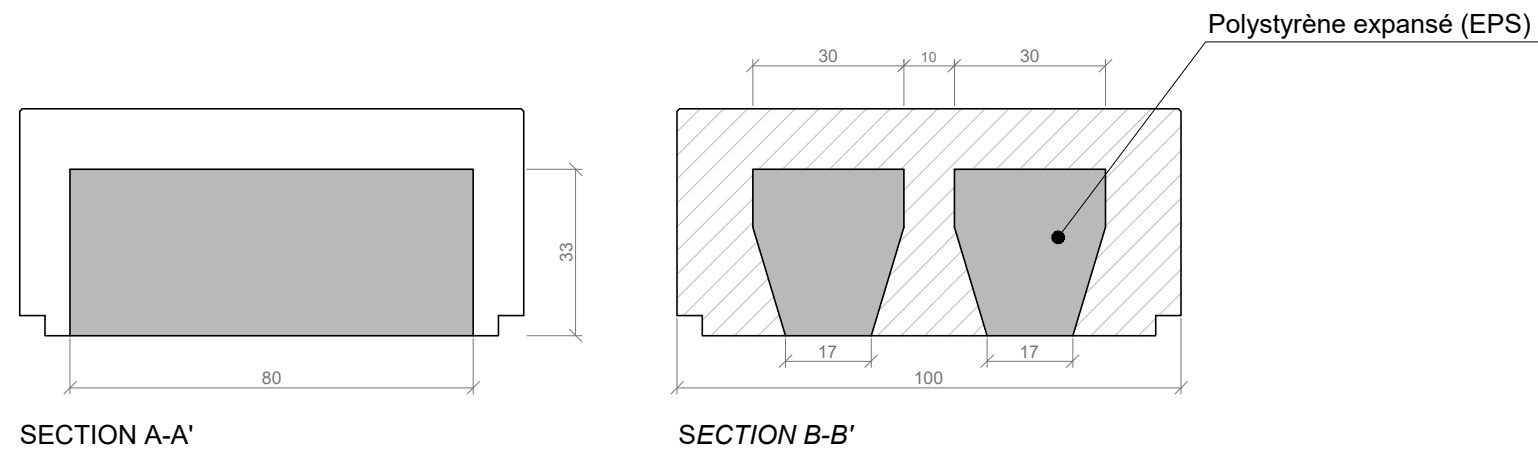

ESC.: 1/15